



3.5 ton
EV chassis

OHM EV

194 Pandan Loop, #04-24
Singapore 128383

Tel. +65 66435637 **Fax** +65 66435639

Website

www.ohmvehicle.com



COMPANY PROFILE

ABOUT US

OUR COMMITMENT TO A CLEANER & GREENER WORLD



OHM designs and manufactures clean, intelligent Electric Vehicles (EV) for light commercial and environmental service applications. All solutions are environmentally friendly (no emissions and low noise), sustainable and energy efficient.

Our vehicles provide body builders with the versatile EV platforms that they require for different applications, and, give drivers safe, reliable, and comfortable working environments.

Established in 2021, OHM is a totally new business, perfectly positioned to build on innovation, new technologies and market demands. There are no legacy systems or inherited working practices which need to be accommodated or modified. OHM is a fresh start in the world of EV.



Our flagship product – the OHM 35 BEV – sets our standards and is leading the way in light commercial electric vehicles. EU approved chassis, on-board charging, unparalleled range performance, fully customisable platform, 2 tons payload, high-efficiency e-axle and inverter, lithium iron phosphate battery with charging and failure protection, and, driver assistance systems – just some of the benefits of this lightweight EV.

OHM operates a 'satellite' manufacturing model with the principal production in China complemented by manufacturing partners in Europe, and, all supported by expert technicians. All production facilities have modern, hi-tech assembly lines. All products are designed, manufactured and tested to the very highest quality standards.

Similarly sales, distribution and service are organised to provide global reach through a network of expert and experienced personnel.

OHM is committed to a cleaner, greener world driven by EVs.

OUR VISION

Commercial electric vehicles (EVs) creating a cleaner, greener environment.

OUR MISSION

To delight vehicle body builders with versatile EV platforms, and reward drivers with safe, reliable and comfortable driving.



OHM 35 BEV



INTELLIGENT/NETWORKING
ELECTRIC CHASSIS

STYLISH & VERSATILE

WE ARE THE FUTURE
OF TRANSPORTATION



NEW CHASSIS, EU APPROVALS GRANTED

EU TYPE APPROVAL: e4*KS18/858*00013*01

PASS UN 29.03
THE EU VEHICLE CRASH SAFETY
REQUIREMENTS,
PRESS FROM ROOF AND CRASH TEST.

PASS UN R100.02
THE EU ELECTRIC VEHICLE HIGH
VOLTAGE SAFETY REQUIREMENT
APPROVAL NR.

PASS UN R10.05
THE EU ELECTRIC VEHICLE E
LECTROMAGNETIC COMPATIBILITY EMC
REQUIREMENT.



3.5T GROSS LADEN WEIGHT LIGHT-WEIGHT CHASSIS, PAYLOAD UP TO 2T

STRUCTURE:
HIGH TENSILE STEEL,
OPTIMIZED CHASSIS STRUCTURE.

MAIN COMPONENTS:
COMPACT CONTROL SYSTEM
3 IN 1 COMBINATION DRIVE-TRAIN,
LIGHT-WEIGHT BATTERY ENCLOSURE.



LOW CONSUMPTION ON COMBINED CYCLE

241 KM RANGE IN COMBINED CYCLE
337 KM RANGE IN CITY CYCLE
(WITH 2,174 KG OF VEHICLE MASS)
BASE REGULATORY ACT: REGULATION (EC) NO 2017/1151.

BATTERY CHARGING

**MINIMIZING DOWNTIME
DURING CHARGING
TRANSITION**

SOC 20% ▶ 90%
WITH DC CHARGER IN
40min



NEDC DISTANCE
280KM

**UNPARALLELED
RANGE PERFORMANCE
UNRIVALLED INTELLIGENCE**

UNRIVALLED 280KM RANGE PER CHARGE.
SURPASSES NEW EUROPEAN DRIVING CYCLE
(NEDC) STANDARD.
REDEFINES PERFORMANCE WITH WHAT REALLY
MATTERS - EFFICIENCY AND PEACE OF MIND.

CHASSIS APPLICATION

KNOWING WHAT MATTERS

FULLY CUSTOMIZABLE PLATFORM FOR ALL YOUR EXTENSIVE APPLICATION NEEDS

ADVANCED CHASSIS DESIGN FOR SEAMLESS SUPERSTRUCTURE INTEGRATION AND A MULTITUDE OF OTHER OPERATIONS WHILE MAINTAINING RIGOROUS SAFETY STANDARDS.

2 TONS PAYLOAD

DUE TO THE LIGHT-WEIGHT CHASSIS, THE COMPACT ELECTRIFICATION SYSTEM AND THE HIGH DENSITY OF THE BATTERY.

ADAPTABLE TO DIFFERENT SUPERSTRUCTURES

REFITTING RECOMMENDATION



WASTE COLLECTION VEHICLE

Light-weight chassis = more payload. i/o port desired by superstructure integrator.



VAN

3000mm wheelbase = multi-dimension boxes customizable.



REFRIGERATOR TRUCK

Responsive & Intuitive control provides constant power output that meets refrigerator systems requirement.



DROP SIDE TRUCK

Light-weight chassis = Multitude of operational possibilities.

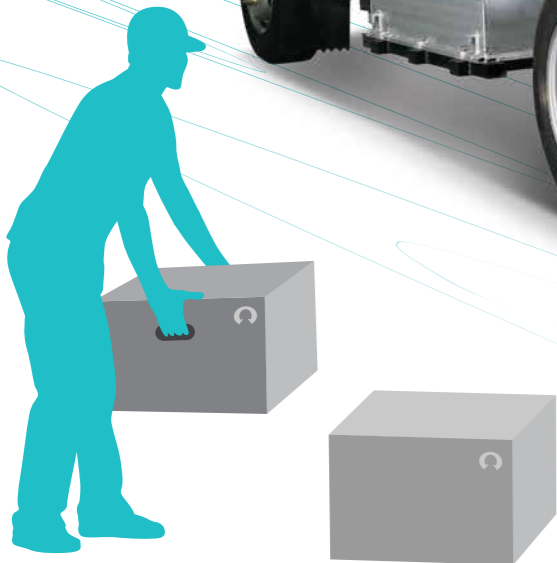

TRANSAXLE

**PEAK TORQUE,
LOW ENERGY
CONSUMPTION**

HIGH EFFICIENCY ELECTRIC MOTOR AND INVERTER TECHNOLOGIES ARE THE RESULT OF MORE THAN 10 YEARS OF EXPERIENCE, RESEARCH AND DEVELOPMENT.

A NEW LEVEL OF OPERATIONAL CAPABILITY WHERE HIGHER SUSTAINED SPEED AND LONGER TRAVELLING DISTANCES ARE WITHOUT IMPACTING THE COST OF OWNERSHIP.

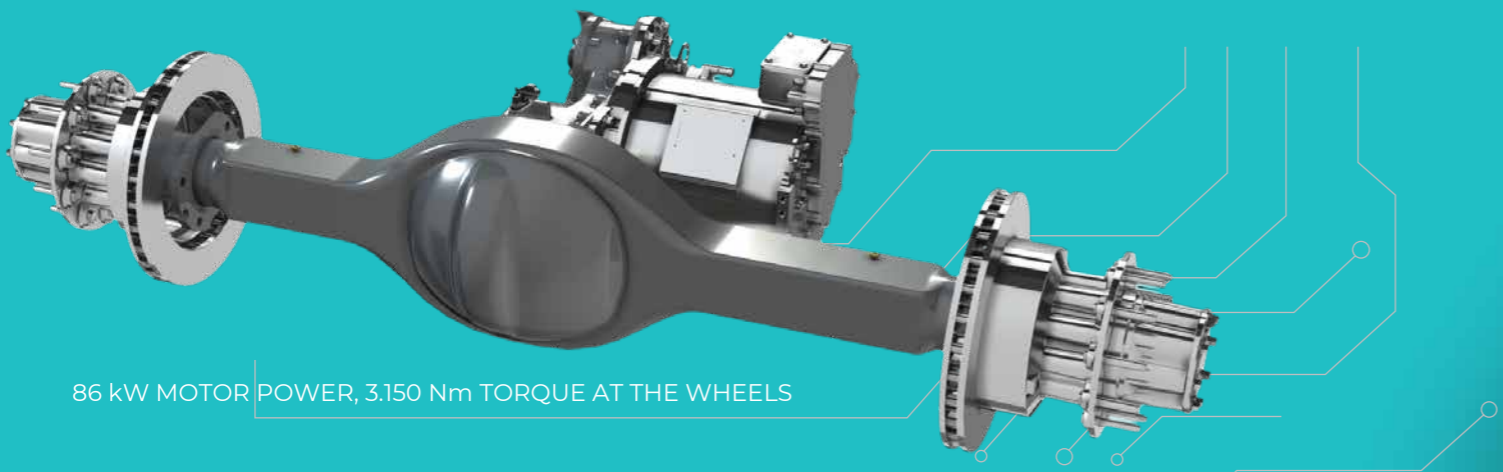

86 kW MOTOR POWER, 3,150 Nm TORQUE AT THE WHEELS

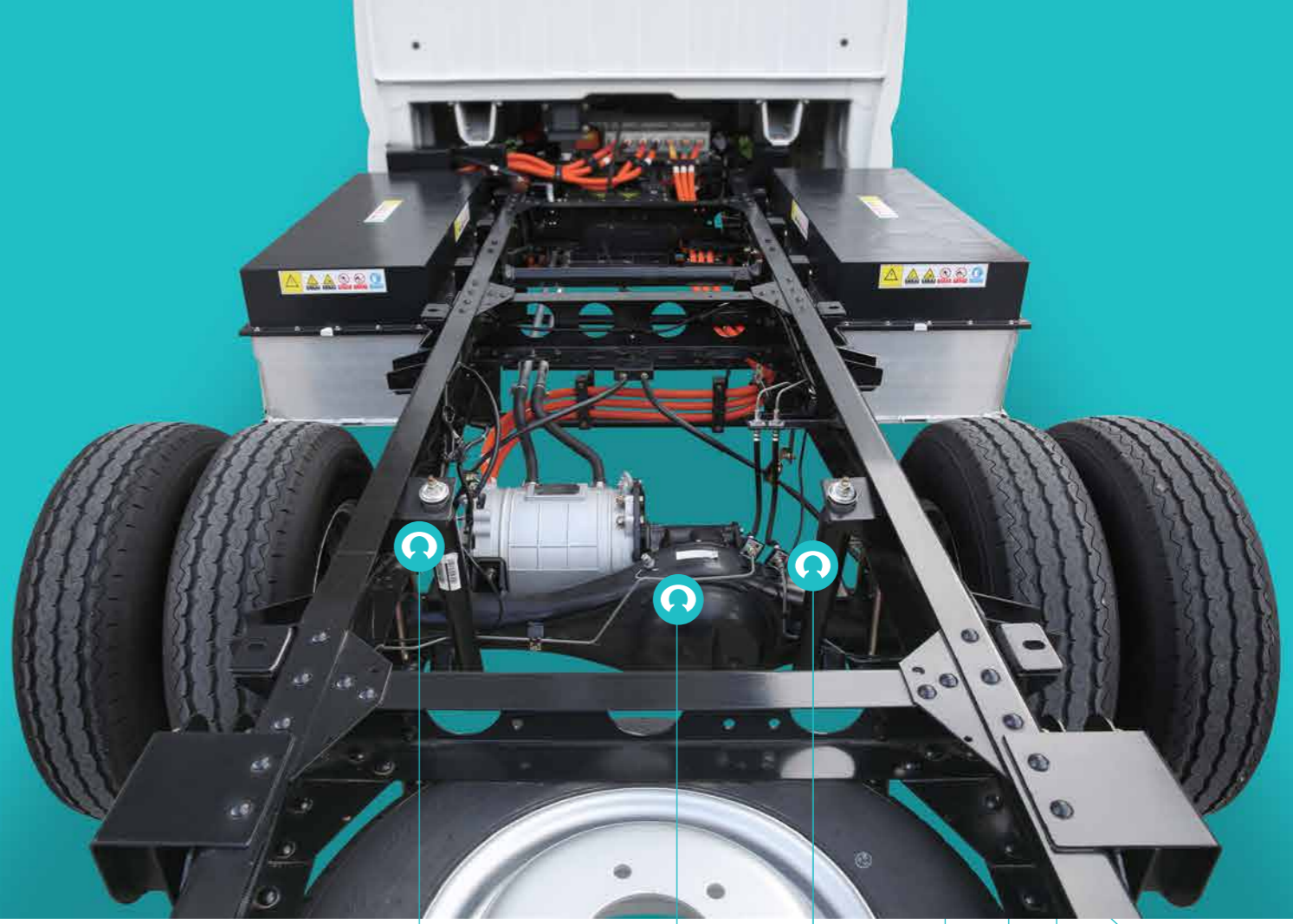

HIGH SPEED PERMANENT MAGNET SYNCHRONOUS MOTOR AND CONTROL ALGORITHMS CONTRIBUTE TO THE HIGHEST POSSIBLE ENERGY CONVERSION EFFICIENCIES.

• EFFICIENCY ENERGY CONVERSION MAP •

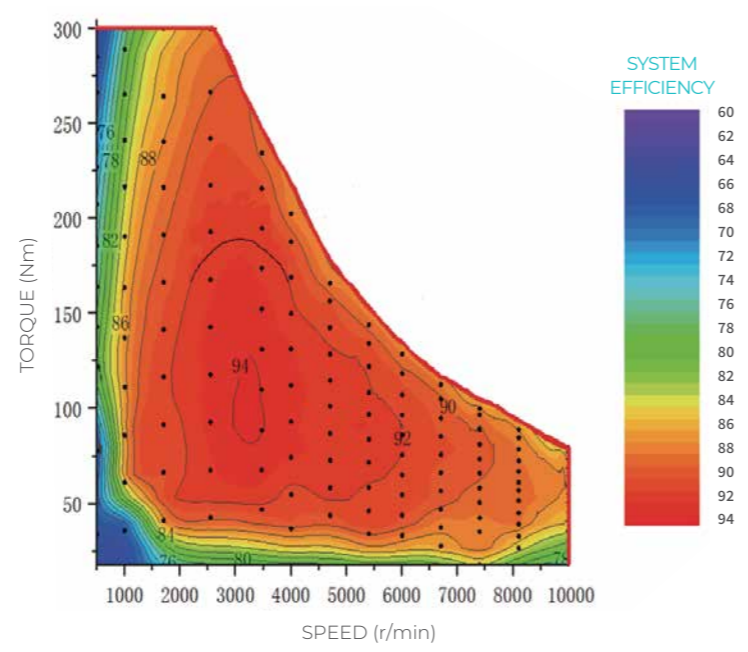

LOW FAILURE RATE: HIGH VOLTAGE CONNECTION POINTS REDUCED BY 47%

3,150Nm PEAK TORQUE AT THE WHEELS



BATTERY

DURABLE, SAFE, INTELLIGENT

- THE LIGHTWEIGHT BATTERY BOX DESIGN REDUCES CHASSIS WEIGHT AND IMPROVES THE MILEAGE.
- MAINSTREAM LITHIUM IRON PHOSPHATE BATTERY, LONG LIFE TIME, SAFE AND RELIABLE.
- FAILURE DETECTION SYSTEM, SAFE AND INTELLIGENT.

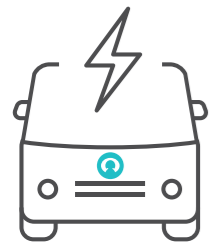

SAFER, INTUITIVE BATTERY MANAGEMENT SYSTEM (BMS)

MAINSTREAM LITHIUM IRON PHOSPHATE BATTERY

Fast charging, high current, efficient and convenient.

INTELLIGENT CHARGING PROTECTION

Real time adjust battery charging strategy, quick, even, safe battery charging.

INTELLIGENT FAULT REMINDER

Battery failure automatic monitoring, failure reminder, ensures vehicle safety.

TESTING

Vibration, mechanical impact, drop, overturn, collision, extrusion, impact, Wet heat cycle, submerging test, external fire, salt fog, high altitude, over temperature protection, short circuit protection, over charging protection, over discharge protection etc, safety tests.



Impact



Extrusion



Submerging



Salt fog



External fire



High altitude



Overcharge and discharge protection



Short circuit protection

3000

Charge cycles

100%

DOD Charge And Discharge

80%

Capacity after 3000 charge cycles

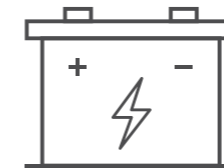

LONG LIFE TIME, DURABLE LIGHT BATTERY BOX

- Lithium iron phosphate battery with high energy density.



- Feather weight battery enclosure material. Safe and sustainable.



- Intuitive monitoring system anticipates battery overcharging and over-discharging activities. Maintains battery normal operating temperature. Prolongs battery life span.



PASS UN R100.02 THE EU ELECTRIC VEHICLE HIGH VOLTAGE, SAFETY REQUIREMENT





EU TYPE APPROVAL: E24*100RO2/04*0089*00

ASSISTANCE

ADVANCED DRIVER-ASSISTANCE SYSTEM

HELPS TO REDUCE STRESS IN TRAFFIC AND INCREASE SAFETY FOR THE DRIVER.





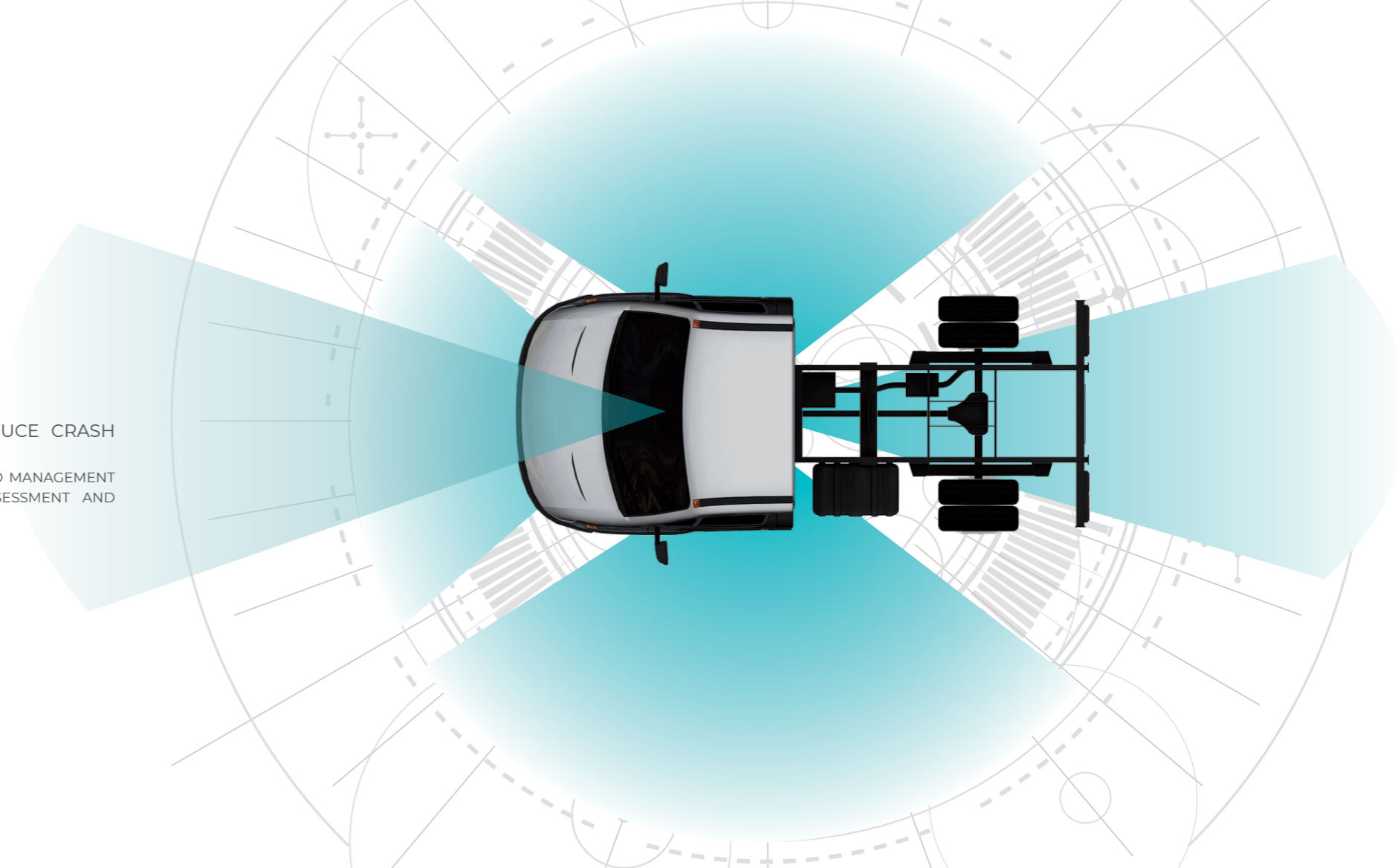



OHM ADVANCED DRIVER ASSISTANCE SYSTEM

-  MONITORS THE ROAD AHEAD.
-  MONITORS DRIVER STATUS.
-  DETECTS BLIND SPOT AND WARNING.
-  ISSUES WARNINGS IN ADVANCE TO REDUCE CRASH ACCIDENTS.
WARNINGS DATA WILL BE UPLOADED TO OHM CLOUD MANAGEMENT PLATFORM AUTOMATICALLY FOR DRIVER RISK ASSESSMENT AND DEDICATE FLEET MANAGEMENT.

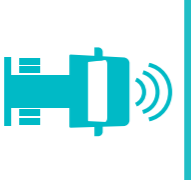

BASED ON LEADING COMPUTER VISION TECHNOLOGY, THE VEHICLE IS CAPABLE OF MONITORING TARGET OBJECTS FROM THE ROAD AHEAD, SUCH AS VEHICLES, LANES, PEDESTRIANS, CYCLISTS, TRAFFIC SIGNS. WHEN THE SYSTEM DETECTS POTENTIAL COLLISION DANGERS DURING DRIVING, IT WILL ISSUE WARNINGS TO IMPROVE DRIVING SAFETY.

WARNING STRATEGIES

	Forward Collision Warning ↑ 2.7s		Lane Departure Warning		Headway Monitoring and Warning
	Virtual Bumper		Front Vehicle Departure Warning		4G Data Transmission
	Pedestrian Collision Warning		Speed Limit Indication 100		Driving Behavior Analysis

FEATURES	DESCRIPTION	WARNING STRATEGIES
Lane departure warning	Lane change without turn signals	Speed >50km/h
Headway monitoring and warning	To close to vehicles ahead	Level 1: Speed >40km/h, TTC <0.8s Level 2: Speed >40km/h, TTC <0.4s
Forward collision warning	High relative velocity to the vehicle ahead	TTC<2.7s
Pedestrian collision warning	Potential collision with pedestrians	Speed <60km/h, TTC <1.4s
Virtual bumper	The vehicle unintentionally moves forward when the vehicle ahead stops	Distance: <1m
Front vehicle departure warning	The vehicle stands still when the vehicle ahead starts to move	Front vehicle departure time: >3s

MONITORING

DRIVER STATUS MONITORING

OHM SYSTEM CAN DETECT THE DRIVERS' HEAD, FACE, EYELID MOVEMENT IN REAL-TIME, AND WILL ISSUE WARNINGS AFTER DETECTING DISTRACTION OR DROWSINESS DURING DRIVING.

WARNING IMAGES AND VIDEOS WILL BE UPLOADED TO CLOUD MANAGEMENT PLATFORM FOR REMOTE SUPERVISION AND RISK ASSESSMENT.



LEADING AI ALGORITHM
COMBINE DEEP LEARNING WITH TRADITIONAL ALGORITHM TO ENABLE HIGHLY ACCURATE RECOGNITION IN COMPLEX SCENARIOS

The system can detect various of driver status with drowsiness or distraction such as **eye closure, yawning, heading down, eyesight deviation, phone calls** and so on. and also can support fatigue status detection in various scenarios even when driver is wearing a **mask, hat, or (sun)glasses**.

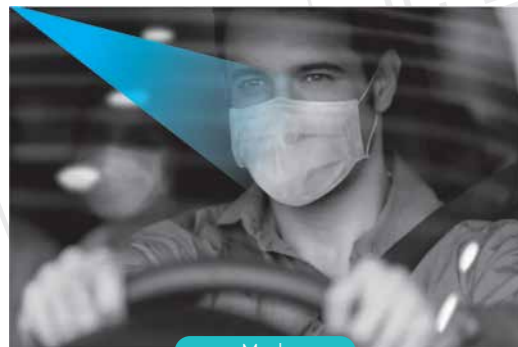

Mask

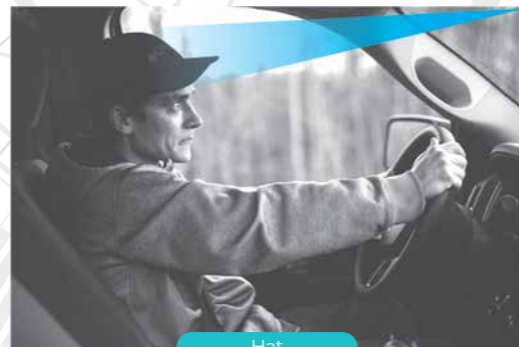

Hat



Heading Down



Drinking



Eyeglasses



Sunglasses



Phone call



Smoking

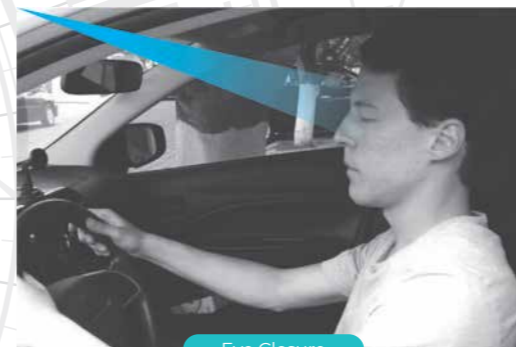

Eye Closure



Yawning

COMFORT

DEVELOPED FOR THE USERS

WHATEVER YOUR MISSION, THE OHM 35 IS THE PERFECT VEHICLE FOR YOUR SUSTAINABLE TRANSPORT COMPANY.

DO NOT LIMIT YOUR BUSINESS BY THE CONSTRAINTS IMPOSED BY ENVIRONMENTAL REGULATIONS, YOU CAN MAKE DELIVERIES TO URBAN CENTERS AND BUSIEST AREAS WITHOUT ANY LIMIT.

NO ENVIRONMENTAL IMPACT THANKS TO THE ABSENCE OF CO2 EMISSIONS.

POWER YOUR BUSINESS WITH THE POWER AND RESPONSIVENESS OF 80KW MOTOR AND 300NM OF TORQUE.

REAL-TIME TYRE PRESSURE MONITORING

- Visualization of pressure data in the instrument panel
- Maintaining optimal tyre pressure
- Safe driving and fuel economy

INFOTAINMENT WITH ANDROID AUTO®

- Navigator with cartography
- Real-time traffic
- Speed limit alerts
- Speed camera
- Voice commands

INTUITIVE INTERACTION

- High-resolution color display
- Clear and simple interface
- Intuitive navigation of fundamental settings
- Easy access to information

INFOTAINMENT SYSTEM

- Viewing clarity with the 7" screen
- Radio DAB
- Driving Style Evaluation
- Mobile device mirroring
- Rear camera

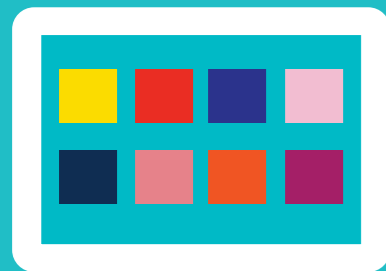

SIMPLICITY AND INTUITIVENESS

The high-resolution colour display and the new user-friendly interface facilitate interaction with the vehicle, allowing access to information in real time.

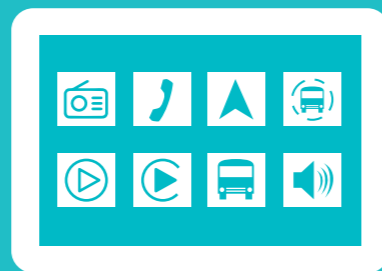

INFOTAINMENT

Bring your digital content on board with Android Auto™ and use your favorite apps thanks to the intuitive infotainment system with 7" screen, DABradio, navigation and much more.



AIR CONDITIONING WITH MANUAL CONTROL

Maintain a pleasant temperature in the cabin with the high efficiency air conditioner that optimizes the use of the compressor, reducing energy consumption.

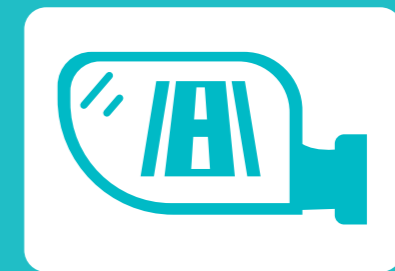

REAR-VIEW MIRRORS

Rear-view mirrors ensure maximum visibility in long vehicles equipped with large bodies.



FRONT COLLISION WARNING

Display collision warning with the front vehicle.



RADIO DAB

Car radio with digital frequency tuner and FM/AM, MP3 player, AUX input on the dashboard.



HEADLIGHTS

High brightness headlights that increase visibility and perception of obstacles..



SEAT COMFORT

Seat, backrest and headrest guarantee the highest level of comfort.

ACCESS CONNECTIVITY

OHM 35 IS EQUIPPED WITH THE MOST UP-TO-DATE TECHNOLOGIES. ANDROID AUTO IS THE SAFEST AND SMARTEST WAY TO USE YOUR SMARTPHONE WHILE DRIVING. GET DIRECTIONS, MAKE PHONE CALLS, SEND AND RECEIVE MESSAGES AND LISTEN TO YOUR FAVORITE MUSIC ON THE NEW INTEGRATED 7" DISPLAY, WHICH CAN BE COMBINED WITH ACCESSORIES SUCH AS REAR CAMERAS, ASSISTED PARKING SYSTEMS, 360° VIEW AND OTHERS.

Vehicle connectivity gives you access to integrated services designed to facilitate your work and increase the profitability of your business.

- REDUCE DOWNTIME**
The OHM 35 vehicle is connected to the Control Room, which constantly monitors its performance and, through remote diagnostics, allows preventive measures to be taken to keep the vehicle always operational.
- OPTIMIZE THE EFFICIENCY OF YOUR FLEET**
From your office or on board, monitor your OHM 35 in real time for maximum efficiency, thanks to the advanced features of the telematics platform that provides you with many fundamental reports for greater care of your vehicle and reduce energy consumption.
- EASILY MANAGE YOUR FLEET**
Take advantage of OHM's comprehensive fleet management solution or use your own system, which will seamlessly interact with the vehicle's web API interface.
- APP MY OHM**
The new MyOHM app is designed to make drivers' lives easier. It can be used to monitor and improve driving style, activate the OHM Assistance service and remotely access vehicle diagnostic data.



OHM CARE SERVICE SOLUTIONS

THE SERVICES OFFERED WITH OHM CARE ARE ORGANIZED INTO FOUR CATEGORIES:

FLEET, FOR MAXIMUM EFFICIENCY OF FLEET MANAGEMENT THROUGH THE MONITORING OF CONSUMPTION AND DRIVING STYLE, MISSION PLANNING, ROUTE OPTIMIZATION AND ORDER SHIPPING.

NOSTOP, TO KEEP VEHICLES ALWAYS OPERATIONAL, AVOIDING UNEXPECTED BREAKDOWNS AND RECEIVING ROADSIDE ASSISTANCE.

GUARDIAN ANGEL, FOR SPECIFIC MONITORING AND REPORTING SERVICES AND THE MYOHM SYSTEM, WHICH WILL LEAVE YOU FREE TO FOCUS COMPLETELY ON YOUR WORK, WITHOUT WORRIES.

NO SURPRISES, TO RECEIVE SPECIALIZED ASSISTANCE THROUGH A SERIES OF TAILOR-MADE MAINTENANCE CONTRACTS.

START PACK

The **START PACK** offers the advantages of My OHM within the following services:

- SMART REPORT**
The driving style evaluation tool algorithm generates weekly reports on the performance of vehicles and drivers, providing suggestions on how to improve driving style to increase fuel economy and optimize vehicle utilization.
- SAFE DRIVING REPORT**
Thanks to the Driving Style Evaluation tool, in addition to the Smart Report you will also receive this new report that allows you to assess the level of safety on board.
- My OHM PORTAL AND APP**
Allows you to monitor the fuel consumption of the vehicle and the driving style of the driver dynamically, so as to identify new ways to optimize the performance of the fleet. You can also schedule and book maintenance appointments efficiently in order to maximize uptime.
- VEHICLE MONITORING AND REMOTE ASSISTANCE:**
The tool for remote diagnostics, teleservices that guarantee a proactive approach and maximize the operating time of the vehicle, anticipating any breakdowns and stops.

PREMIUM PACK

The **PREMIUM PACKAGE** offers the services included in the **START PACK**, plus all the advantages of **NOSTOP**, **GUARDIAN ANGEL** and **NO SURPRISE**. It guarantees a follow-up on the data sent by the vehicle by putting you in touch with OHM experts, which will suggest you how to use them in the best way.

DESCRIPTION

CONFIGURATION	MODEL CONFIGURATION	REMARKS
L*W*H (mm)	4885 x 1760 x 2000	
Wheelbase (mm)	3000	
Max. allowable rear overhang (mm)	1205	
Mass in running incomplete vehicle (kg)	1635	
Technical allowable maximum load mass (kg)	3495	
Technical allowable mass on front axle (kg)	1700	
Technical allowable mass on back axle (kg)	2800	
Maximum speed (km/h)	90	
NDEC Driving Range (km)	280	NEDC
Pure Electric Range (km)	241	WLTC Road conditions, Test Mass 2173 kg

BATTERY CHARGING SYSTEM

DC Charging (Mode 4)	Up to 80 kwh
DC Charging (Mode 3)	Up to 7 kwh

POWER BATTERY PARAMETERS

Installation location	Side-mounted
Cell type	LiFePO4
Battery pack energy density(Wh/kg)	142.18
Single pack voltage(V)	193.2
Vehicle voltage(V)	386.4
Single pack of electricity (kWh)	30.9
Total pack of electricity (kWh)	61.8

POWERTRAIN

Motor type	Permanent magnet synchronous motor
Rated/Peak power(kW)	40/80
Rated/Peak torque(Nm)	110/300
Rated/Peak speed(rpm)	3473/8700
Integrated controller	integrated MCU DC/DC
Cooling method	Water cooling

EXTERNAL CONFIGURATION

Steel wheels	●
Wheel trim cover	—
Rear wheel fender	—
Tubeless radial tire	●
Spare tyre	●
Front anti-collision beam	—
Side anti-collision beam	—
Rear anti-collision beam	—
Tow hook	Front/Rear
Speaker	high-pitched speaker only
Rearview mirror	●
Power windows	●
Left/right sun visor	●
Intermittent front wiper	●
EPS	●

INTERNAL CONFIGURATION

Four-way adjustable steering wheel	—
Multifunction steering wheel	—
Cigarette lighter	●
Inner Rear View	●

AIR CONDITIONING CONFIGURATION

Manual air conditioning (cold/warm)	●	Electric compressor/PTC
-------------------------------------	---	-------------------------

LIGHTING CONFIGURATION

Low beam lights	●
Halogen headlights	●
LED headlights	—
Manual adjustment of headlights	●
Automatically turn-on headlights	●
High beam	●
Front turn signal	●
Front position light	●
Front fog lights	●
LED day and night driving lights	●
Side turn signal light	●
Front marking light	—
Front marker light	—
Rear license plate light	●
Indoor reading light	●
Rear combination lamp	●

MULTIMEDIA CONFIGURATION

Radio	●
Multimedia system	●
Navigation system	□
Connectivity box	●
Dual USB	—
Number of speakers	2

SECURITY CONFIGURATION

Brake type	Front disc and rear drum
Reversing buzzer	●
Main/passenger cabin airbag	—
Main driver's seat belt sound and light alarm	●
Co-pilot's seat belt sound and light alarm	●
Central control door lock	●
Three-point seat belt for main driver	●
Co-pilot three-point seat belt	●
Alarm when the door is not closed	—
Top handle	●
Fire extinguisher	●
ABS	●

SEAT CONFIGURATION

Main driving seat (PU Leather)	●
Co-pilot driving seat (PU Leather)	●

Notice: "●" included, "—" not included, "□" optional.

VIEW (SIDE/REAR)



SIDE



REAR

COLOUR (WHITE/SILVER)



CLEAR WHITE



COOL SILVER